

Carl Hamm
Pipesystems



ZSM

CONNECTION



Carl Hamm ZSM Connections

The tight sleeve connection – ZSM – is an axial non-positive and detachable pipe connection. Used as a vertical riser pipe in open pit and underground mines as well as in deep wells.

Our patent-protected tight sleeve system is a unique alternative to other conventional connection systems due to its quick and easy assembly/disassembly and space-saving design. All of this ensures considerable cost savings through the whole life cycle.



ZSM Connection with corrosion-proof coating

- **Reduced installation dimensions.**
- **Quick, easy and safe to assemble/disassemble.**
- **No special tools.**
- **The ZSM Connection permits low deflections.**

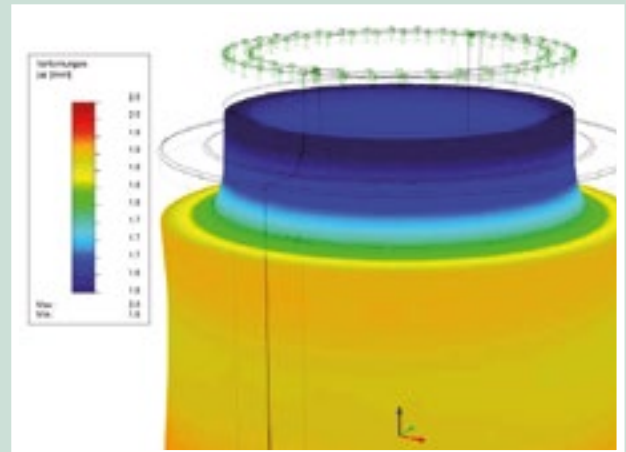

FEM calculation

Technical Data

Dimensions	2"-65" / DN 50-DN 1400
Nominal pressure	up to PN 400
Axial forces	up to 1600 tonnes (rupture loads)

The ZSM Connections were examined at the DMT Rope Testing Centre and various tensile tests were conducted for the maximum rupture loads.

The development of the ZSM Connection was based on FEM calculations.

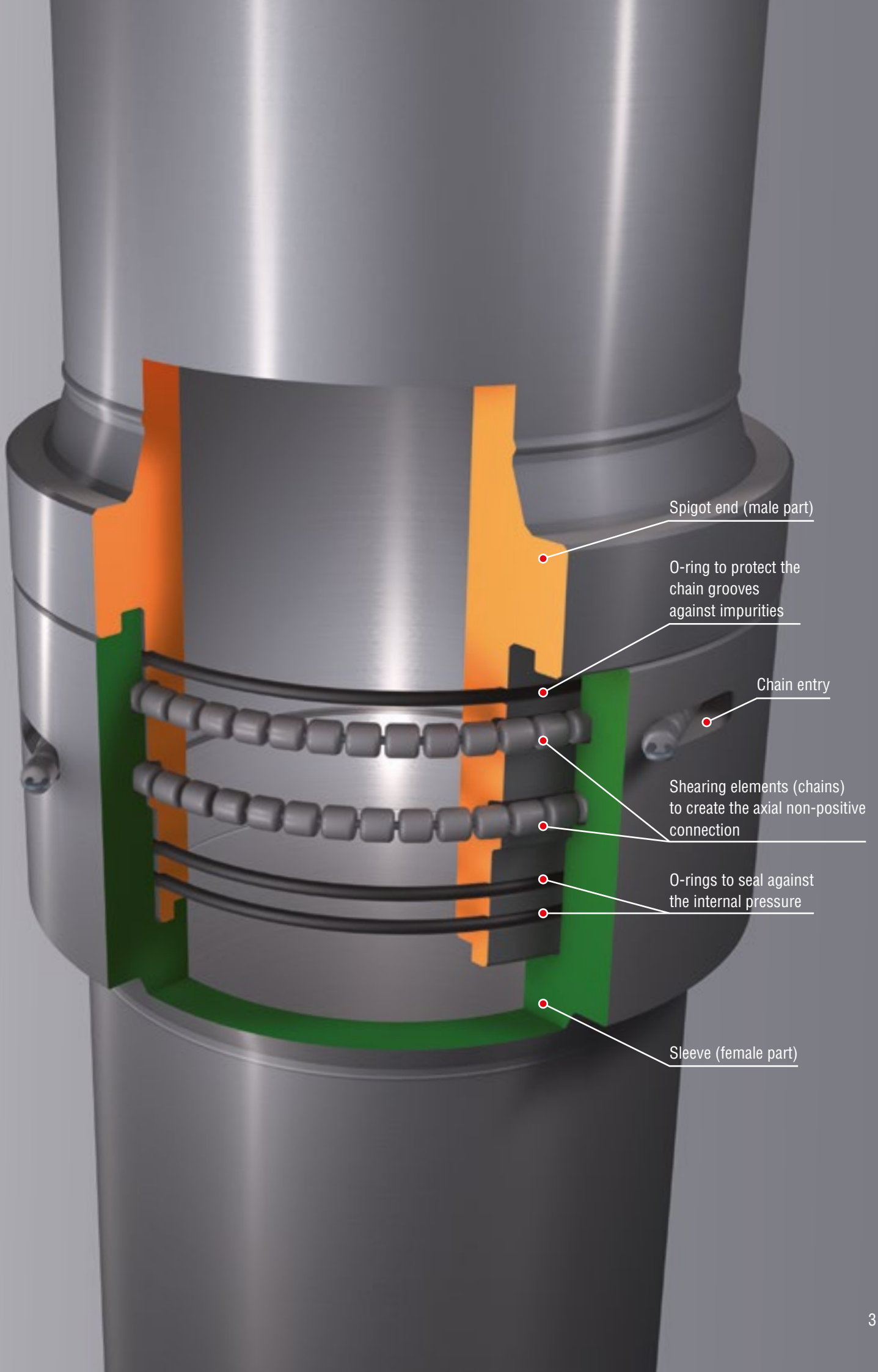

The success story of the Carl Hamm ZSM Connection

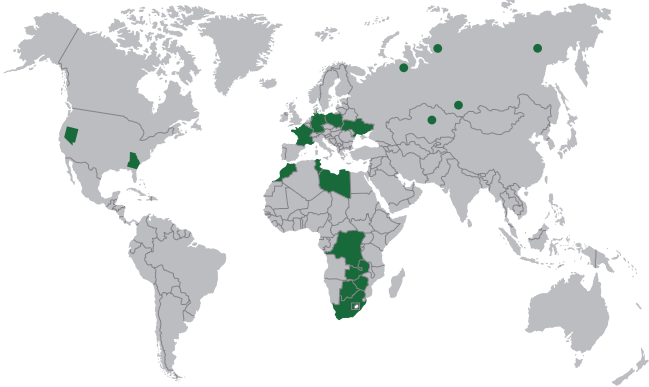

Realized projects with the Carl Hamm ZSM connection since 1998

The ZSM Connection was launched in 1992 as a simple, quick, tight connection – initially used as a lost casing in well sinking.

The potential of this connection was recognised in the mid-1990s. The ZSM Connection was further developed in cooperation with Rheinbraun (now called RWE Power). The objective was to create a medium-carrying, axially load-bearing, quick-to-install system with detachable connections. The results revolutionised the well operations of Rheinbraun. As a consequence, all wells are now operated with ZSM pipelines.

The ZSM Connection was further developed for use underground on the basis of this technical success.

In 2003, the first riser pipe was equipped with ZSM-Technology in German hard coal mining – Heinrich colliery, Essen. In such cases the higher tensile and compressive loads as well as the high safety requirements in a shaft used for descent were taken into account.

The ZSM Connection was continuously developed and also successfully used in a wide range of installation situations in German mining and more recently internationally as well.



Installation of a ZSM Pipeline



Easy fitting of the shearing elements

Easy installation

- The spigot end (male part) has three sealing grooves and two chain grooves on the outside.
- The sleeve (female part) has two chain grooves on the inside.
- O-rings are inserted into the sealing grooves of the spigot end.

- The spigot end and sleeve are pushed together without any additional aids.
- The seal is created in this way.
- The optional anti-torsion devices absorb the torsional moments of the pump.

- The chain grooves form two annular cavities.
- Shearing elements (chains) are inserted manually through openings in the sleeve. Tools are not required.
- The spigot end and sleeve therefore have an axial non-positive connection.

- The chains can be simply withdrawn again for disassembly. The pipeline can be separated.

ZSM vs. flange

	ZSM	Flange
Hydrostatic forces	O-ring (gasket)	Bolts, nuts, gaskets with a defined tightening torque
Axial forces	Shearing chain	
Torsion forces	Torsion safety element	
Tools	–	Impact wrench

Carl Hamm ZSM in underground mining

The ZSM Connection excels owing to its cost-effectiveness, especially when used with high-performance submersible pumps.

Here it shows off its system advantages of time-saving assembly and disassembly.

In confined installation situations the low installation dimensions of the ZSM Technology allow optimised pipe diameters.

The easy disassembly of the pipes allows to change a pump quickly. Downtimes due to maintenance and repairs are reduced to a minimum.



Stainless steel, ZSM Sleeve



Corrosion-protected ZSM Sleeves



Hydraulic assembly flap



Acid mining dewatering, Johannesburg, South Africa

German mining

Realized major projects since 2002

Customer/Plant	DN	m
EON/Huntorf power station	500	3 x 700
K+S/Esco Werk Braunschweig	200	480
RAG/Amalie	350	3 x 900
RAG/Auguste Victoria	350	800
RAG/Camphausen	250	800
RAG/Carolinenglück	300	2 x 830
RAG/Carolinenglück	500	2 x 950
RAG/Concordia	300	3 x 1050
RAG/DSK Ibbenbüren	500	600
RAG/Duhamel	1400	5 x 585
RAG/Heinrich	500	4 x 485
RAG/Prosper	350	2 x 800
RAG/Rob. Müser	350	2 x 600
RAG/Rossenray	400	1050
RAG/Saar	400	1000
RAG/Walsum	300	3 x 830
RAG/Zollverein	500	2 x 1050

Freely suspended

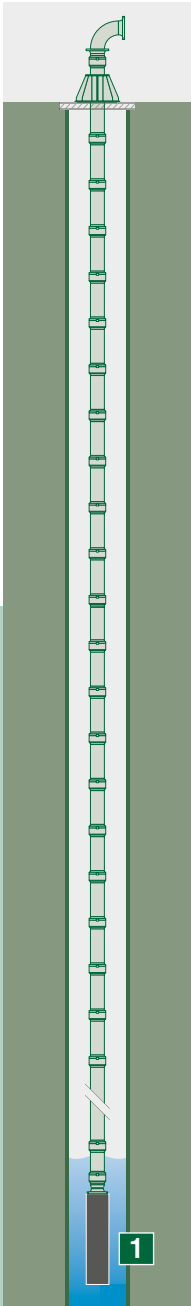

Freely suspended

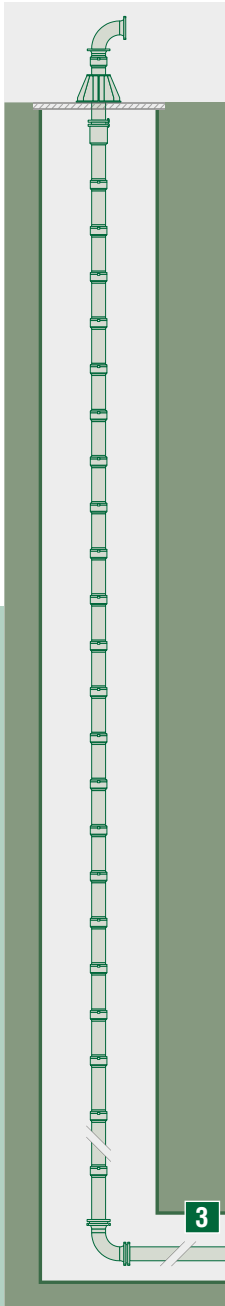

Partially suspended

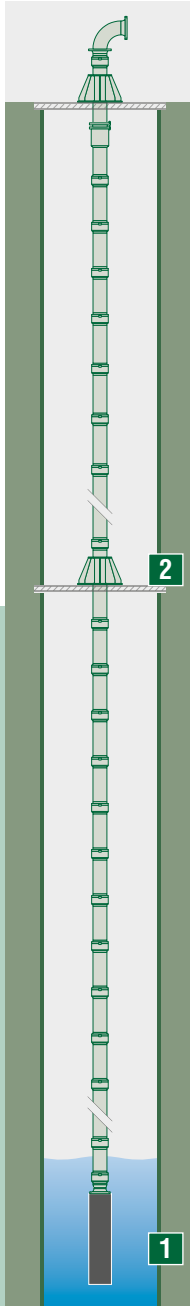

Partially suspended

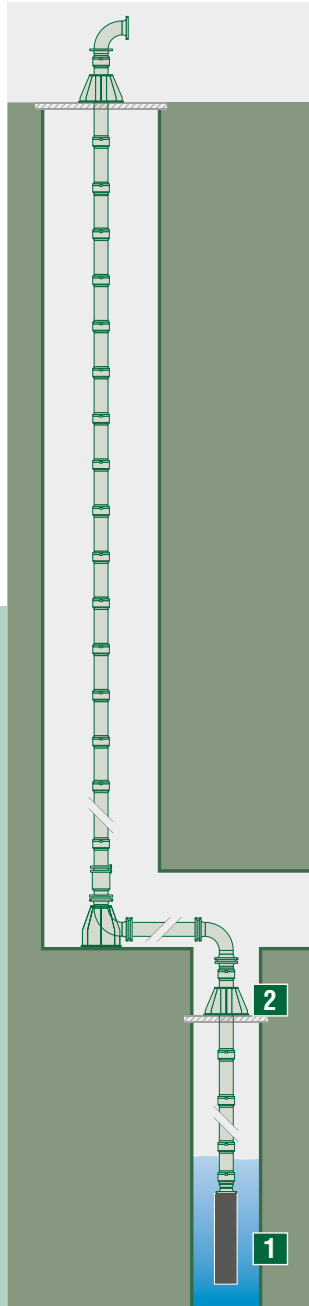

Standing pipe column

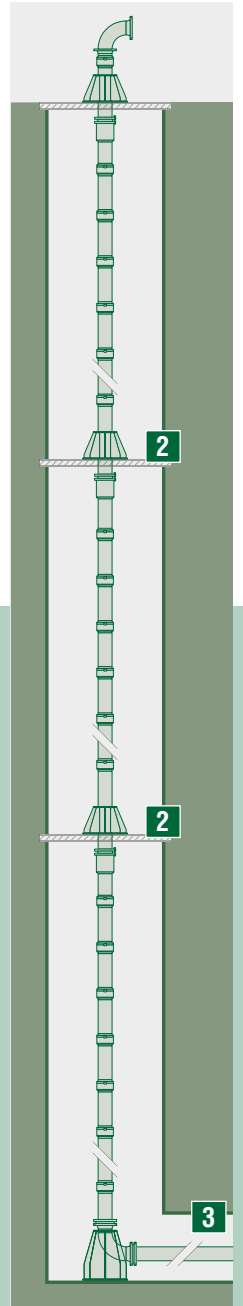

1 Pump 2 Intermediate support point 3 To pump station

Installation situations of the Carl Hamm ZSM Connection

International mining		
Realized major projects since 2010		
Customer/Plant	DN	m
Congo (DRC)/Kipushi	300	400
Poland/Copper mining	350	2 x 1000
Russia/Alrosa	250	3 x 550
South Africa/Johannesburg	400	7 x ca. 400
USA/Atlanta	750	4 x 85
USA/Las Vegas	800	135
Zambia/Kanshansi	400	400

Carl Hamm ZSM in deep-well sinking

The ZSM Technology has been used for more than 20 years in German brown coal open-pit mining to manage the groundwater level. Especially in well galleries with a high amount of interconnected wells the advantages of the ZSM-connection are emphasized.

The frequent pump changes – due to high solids content of the pumped medium and the moving open-pit – can be executed much faster because of the very short assembly and disassembly times.

The low installation dimensions of the connection allow higher pipe diameters. As a result, lower velocity can be achieved at the same pump capacity by even enlarging the system efficiency. Also this ensures a substantial extension of the service life of a pipeline and the pump used.

The ZSM Technology is also very popular for applications in irrigation projects with deep wells, especially due to the advantage of the low installation dimensions and short installation time and its resultant benefits.



Corrosion-protected
ZSM Pipes



Application possibilities for irrigation using deep wells



ZSM Connection, stainless steel



Welding of the spigot end and pipe



Use of the ZSM for groundwater management in brown coal mining

German brown coal mining

Projects implemented since 1998

Customer/Plant	Dimensions	Well	Total length
RWE Power	2" to 16" / DN 50 to DN 400	approx. 2000	800 - 1650 ft / 250-500 m



Brown coal open-cast mining

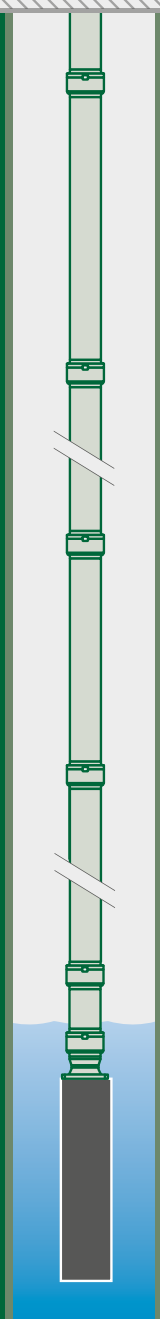

Everything from one source

We supply ready-to-install ZSM Pipelines.

To offer optimum solutions, we apply to our experience from over 90 years in the mining industry. We ensure to support our customers in all phases of their projects.

Our services:

- Budget planning on the basis of your information (see adjacent table).
- Planning of a pipeline including all components required.
- Static calculations.
- Preparation of the overview and detail drawings.
- Design of the ZSM Components on the basis of the specific requirements.
- Destructive tensile testing of the ZSM Components.
- Professional production of the complete pipeline using the in-house process – according to the specific manufacturing and test sequence plan.
- Depending on the requirement, we produce ZSM Pipelines made of:
 - Carbon steels (e.g. P355 ff)
 - Stainless steels (e.g. 1.4571)
 - Duplex steels (e.g. 1.4462)
- Inside and outside coating systems.
- Non-destructive tests of the welds.
- Worldwide shipment.
- Support during assembly.



Planning and conceptual design



Mechanised welding line



Documented quality testing

Budget planning on the basis of your information (details required):

1. Installation situation (see page 7)
2. Pipeline length
3. Individual pipe length
4. Diameter/dimensions
5. Weight of pump/motor/cable
6. Pump feed pressure
7. Spacing of intermediate support points
8. Corrosion protection
9. Details of the safety concept (official specifications)

Quality management

A certified quality management system was introduced in 1997. The development and design section was added in 2010.

As a certified specialised welding company, we satisfy national and international standards.

Certificates, permits (e.g. Germanischer Lloyd) and process inspections as well as the personal qualifications of our employees in the production and quality assurance departments guarantee a constantly high standard of quality.

Extract:

- | | |
|--------------------------------------|----------------------------------|
| • Quality management system | DIN EN ISO 9001:2008 |
| • Welding quality requirements | DIN EN ISO 3834-3 |
| • Inspection of the production shops | AD 2000 HPO |
| • In-house quality control | EN 1090-1:2009 + A1:2001 |
| • Manufacture of steel structures | EN 1090-2 |
| • EC Certificate of Conformity | CE marking of pressure equipment |
| • Process inspections | DIN EN ISO 15641-1 |
| • Welding staff | DIN EN 287-1 and DIN EN 1418 |
| • NDT (RT, PT, MT, VT) | DIN EN 473 – Level 2 |



Non-destructive testing



Worldwide shipment



Pipes | Pumps | Solutions

Competence, experience, innovative thinking, modern manufacturing plants and motivated employees form the basis of our services.

With the flexibility of a modern, medium-sized company and the experience of our over 90-year history, we are well equipped to meet the requirements of the future.

The numerous certifications and technical approvals of course ensure that we serve our customers with the highest quality standards through the complete project phases.

Our product range focuses on water, waste water and power industries, tunnel construction and well sinking as well as open-pit and underground mining.

We as a competent partner ensure an added value for the specific customer needs: from the conceptual planning to professional production and punctual delivery.



Headquarter of Carl Hamm in Essen, Germany

Röhrenwerk Kupferdreh Carl Hamm GmbH

Gasstraße 12
45257 Essen
Germany

info@carl-hamm.de
www.carl-hamm.de
Tel.: +49 (0) 2 01 / 8 48 17 - 0

Carl Hamm PPS (Pty.) Ltd

2 Bickford Street, Founders Hill,
Lethabong, 1609

chris@carl-hamm.co.za
www.carl-hamm.co.za
Phone: +27 (0)72 256 0926